

Car Workshop Light Installation Manual

Model: ZT1018

WARNING!!!

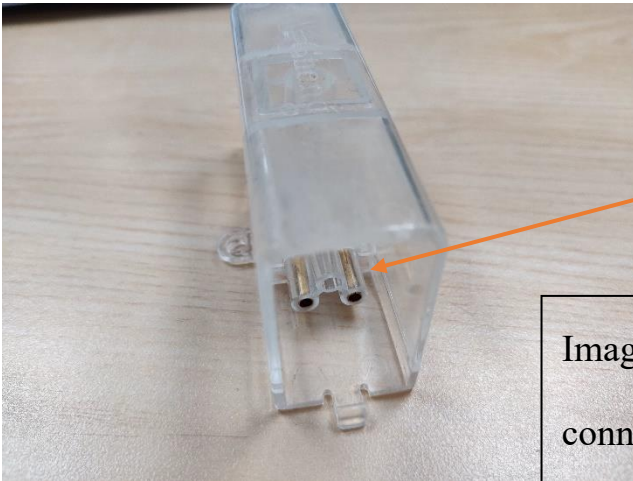
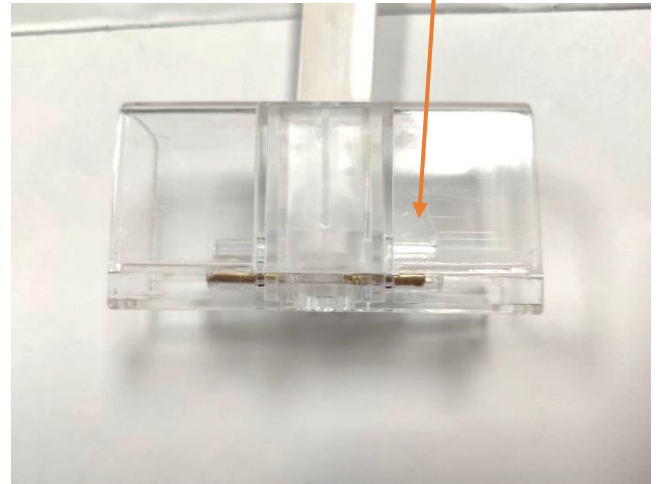
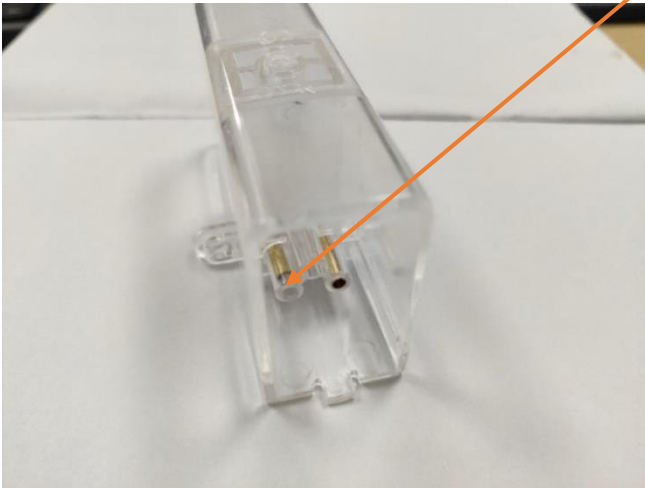

Image 1 shows how the copper connectors are supposed to look.

Image 2 and Image 3 show damaged copper connectors, which happens when the units are pushed together with excessive force.



If two units do not seem to fit together easily, double check that the connectors are accurately lined up or try using a different lamp. Do not force the connection.

Test the entire light set with a multimeter before hooking up to an electrical source and before mounting to the ceiling.

It is recommended to completely read this manual before assembling the product.

Contents

1. Design Sketch.....	2
2. Parts List.....	2
3. Other Parts List.....	2
4. Technical Data.....	3
5. Assembling Instruction.....	3
6. Circuit Diagram.....	5
7. Mounting Instruction.....	6

Design sketch

(Please carefully read the “**Circuit Diagram**” before assembling)

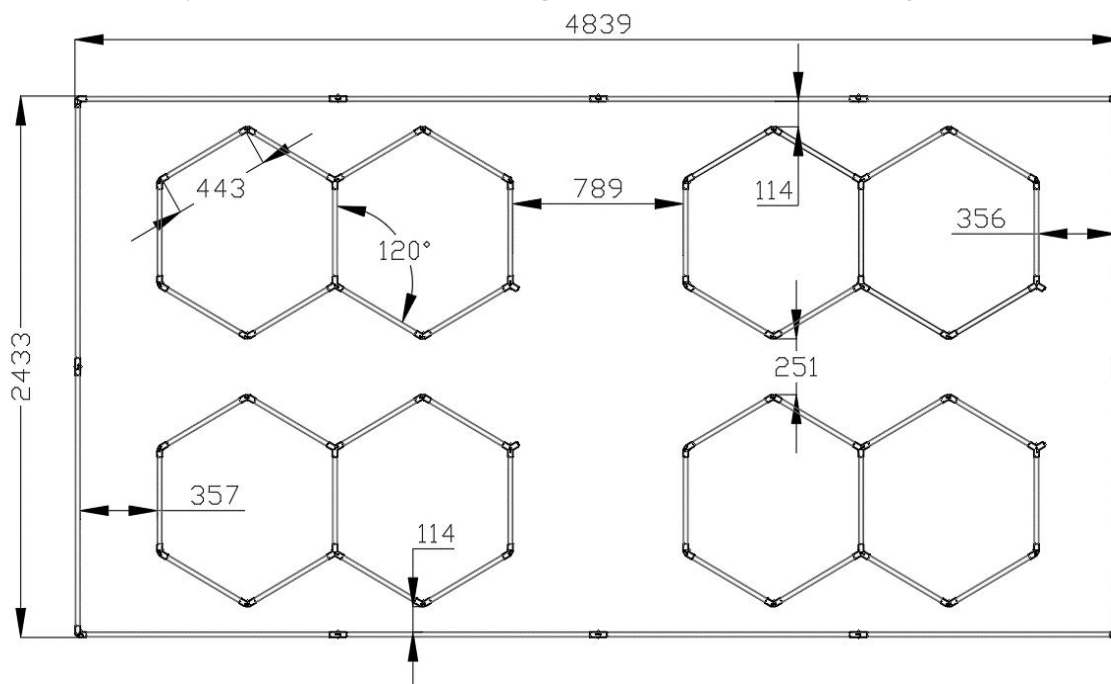

Parts List

No.	Name	Specification	QTY	Unit	PIC
1	tubes	Size: 440*20mm Power: 6w	44	pieces	
2	tubes	Size: 1185*20mm Power: 16w	12	pieces	
3	connectors	90° 2-way white	3	pieces	
4	connectors	180° 2-way white	8	pieces	
5	connectors	T-shaped 3-way white	1	pieces	
6	connectors	120° 2-way white	28	pieces	
7	connectors	120° Y connector white	12	pieces	
8	The cable	1-end	5	pieces	
9	installation instruction	-	1	pieces	

Other Parts List

Provided by buyers

No.	Name	Specification	QTY.	Unit	PIC
1	Wires	≥1.5mm ² for wiring	5-15	m	

Technical Data

Voltage	AC110V
Power	456W
Current	8.4A
Luminous Flux	110-120lm/w
CRI.	>90
CCT.	6500K (White)

Assembling instruction



1. Put all the lamps and connectors on the ground (as follow picture).

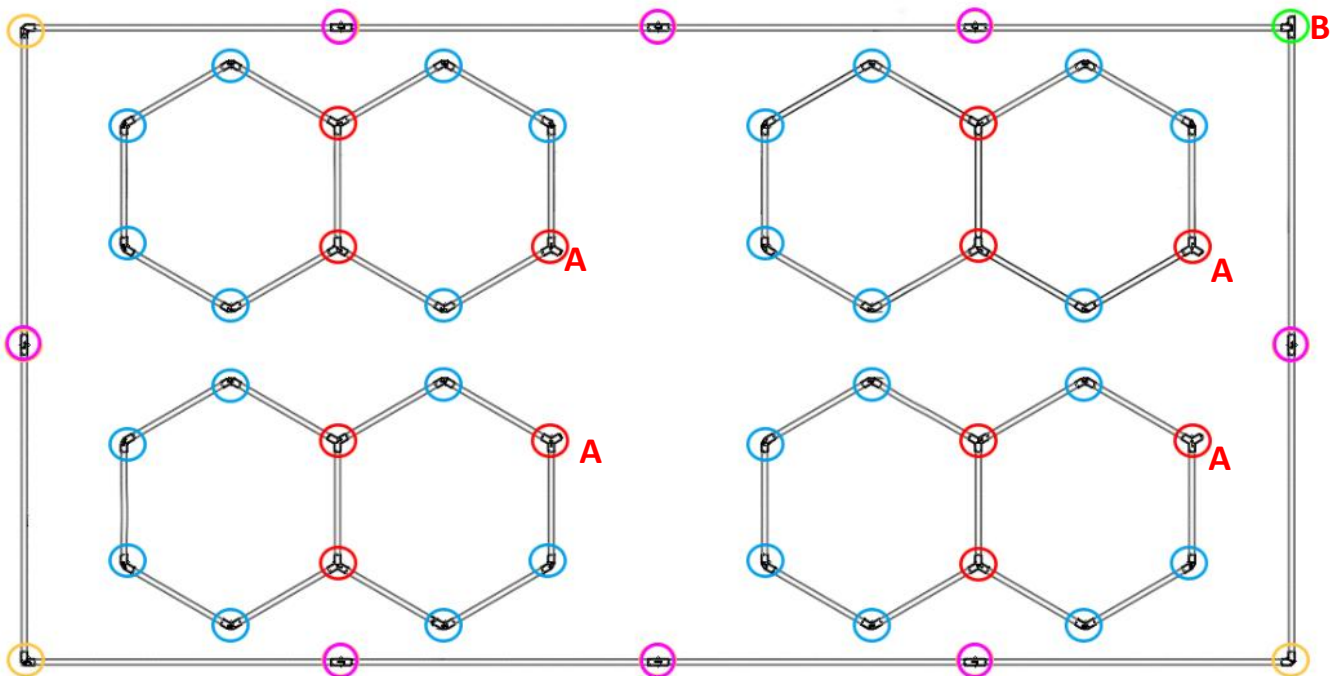

1.2m lamps for outline, 0.44m lamps for inner structure, and the position of different connectors as follow picture shows:







Pink O for 180° 2-way connectors



Yellow  for L-shaped 2-way connectors 

Blue  for 120° 2-way connectors 

Red  for Y-shaped 3-way connectors 

Green  for T-shaped 3-way connectors 

2. Connect the tubes (Please be careful while connecting tubes with the connectors, or the copper needle in the connectors would be damaged)

3-way connection:

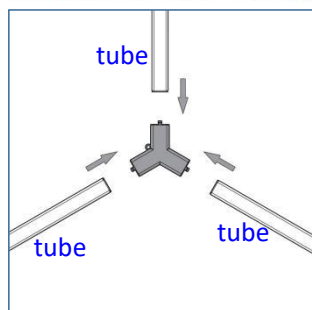

2-way connection:

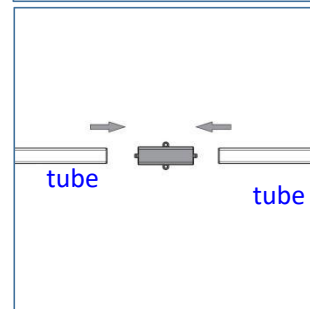
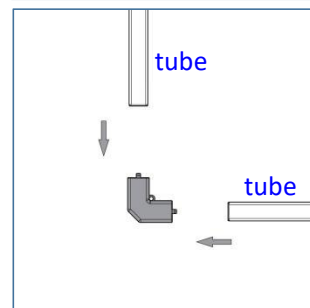
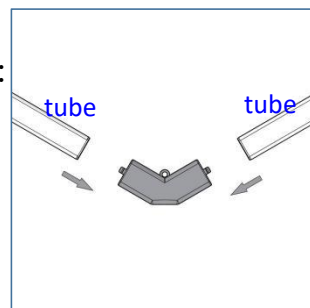

connection at point A:

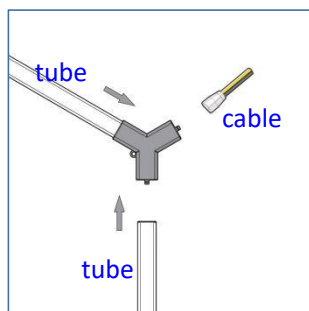

connection at point B:

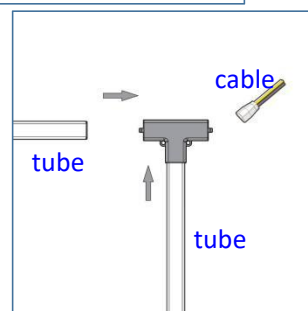

Circuit Diagram

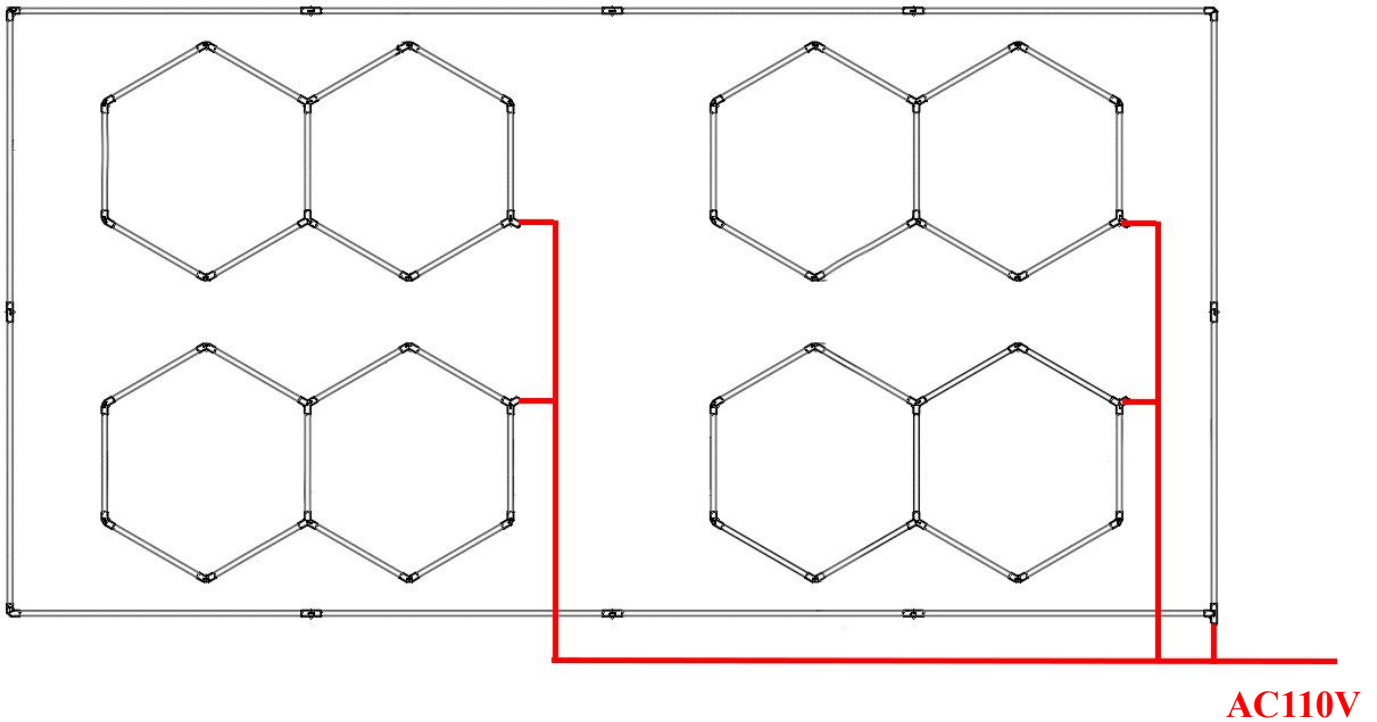

Caution!

1. About the cable:

Red wire—Live Line

Blue wire—Null line

Yellow wire—Earth Line or Ground line

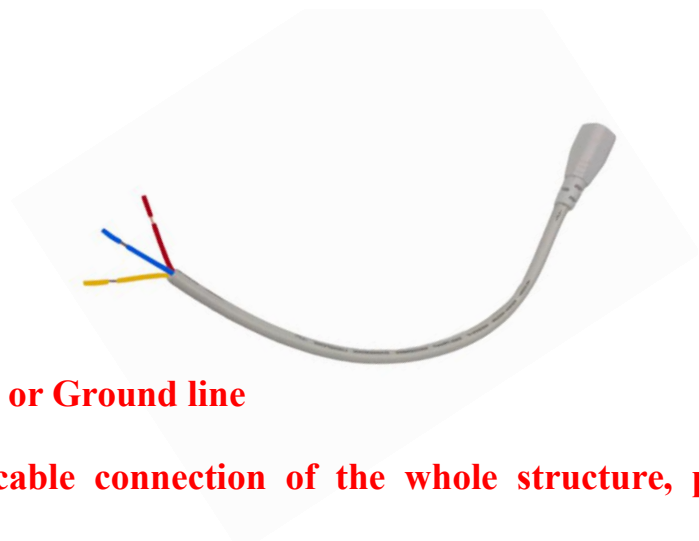

2. There are only 5 points for cable connection of the whole structure, parallel connecting the 5 cables and wiring to AC110V

3. TEST BEFORE FIXING TO THE CEILING.

4. Please installed by professional electrician.

Mounting instruction

How to fix it on the ceiling?

A grid roof

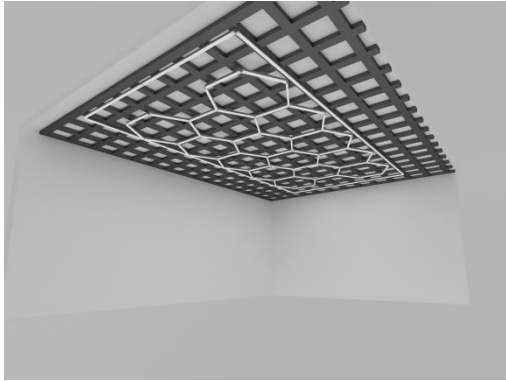

Tie it with ribbons

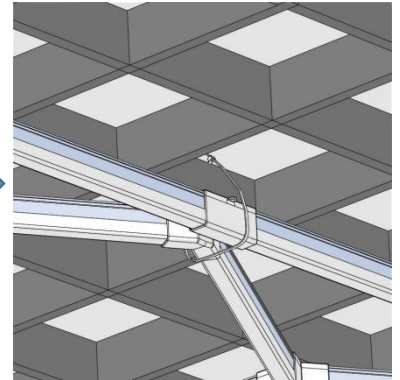

B flat roof

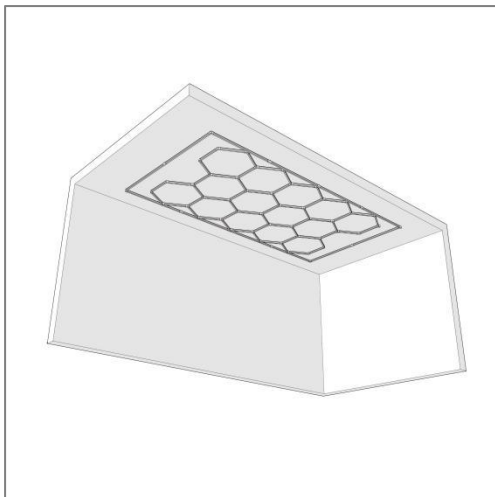

Screw the connector from the hole to the ceiling directly

